

AGRICULTURAL PARTS

6 SERIES

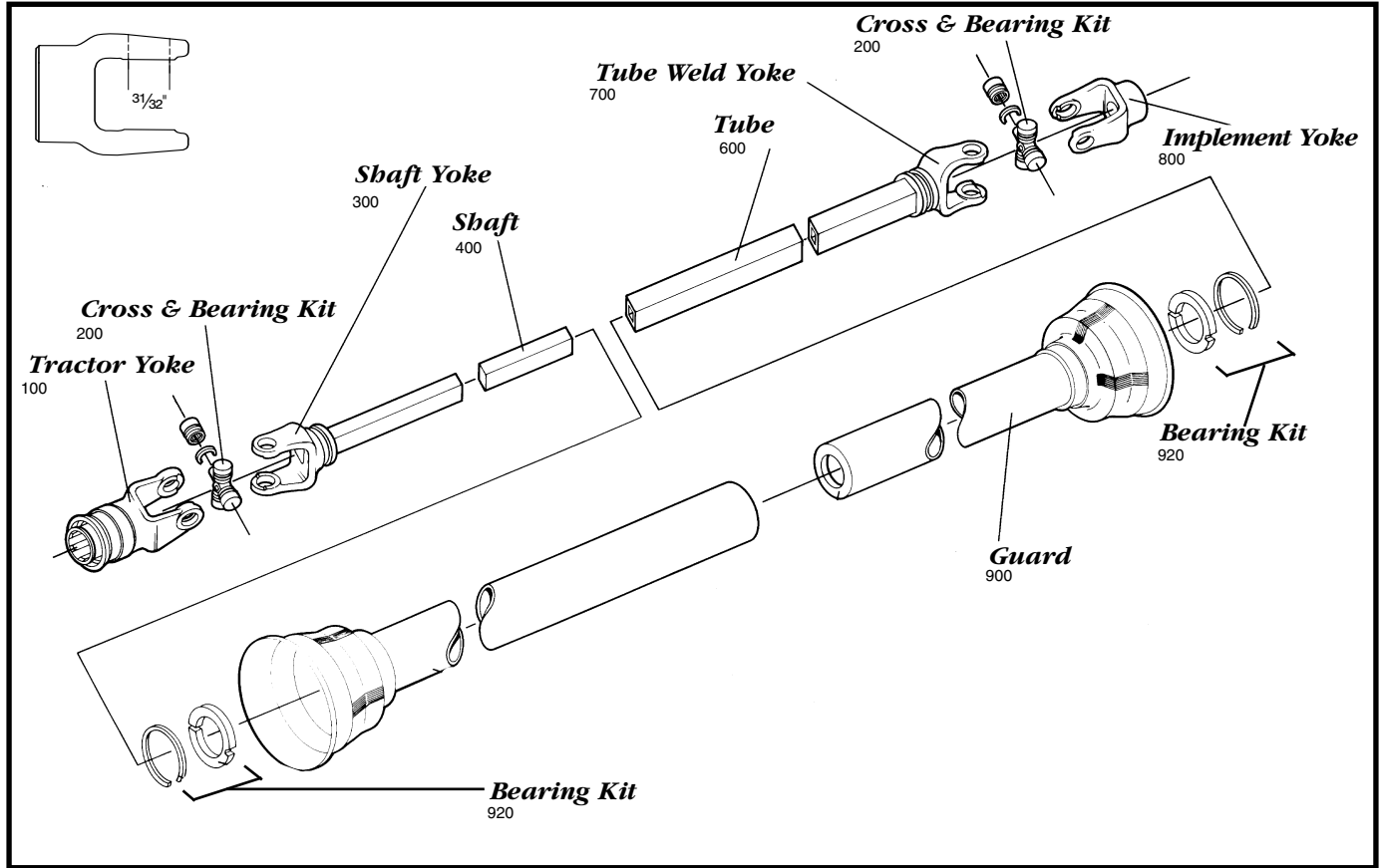

Tractor Yoke

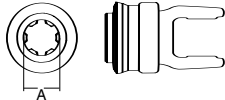

Spring-Lok

SPECIFICATIONS		
RB&H #	REFERENCE #	DIM. "A" BORE (IN.)
100-0606	6R220-20-SL	1 3/8 x 6
100-0621	6R220-TQD-SL	1 3/8 x 21

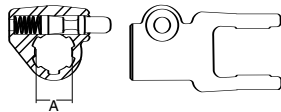

Quick Disconnect

SPECIFICATIONS		
RB&H #	REFERENCE #	DIM. "A" BORE (IN.)
102-0606	6R220-20	1 3/8 x 6
102-0621	6R220-TQD	1 3/8 x 21

Repair kit – page 200

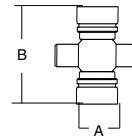

Cross & Bearing Kit

SPECIFICATIONS				
RB&H #	REFERENCE #	DIM. "A" (IN.)	DIM. "B" (IN.)	
200-0600	1-1475	6R	31/32	2 9/32
201-0600	–	ExtLife E Series	31/32	2 9/32

Snap ring located in bushing

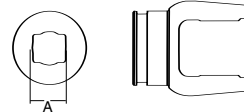

Shaft Weld Yoke

SPECIFICATIONS		
RB&H #	REFERENCE #	DIM. "A" BORE (IN.)
300-0600	6RWY1214	3/4 x 7/8

With bearing groove

AGRICULTURAL PARTS

6 SERIES

Implement Yokes

Shaft



3/4" X 7/8" RECTANGULAR

SPECIFICATIONS

RB&H #	REFERENCE #	LENGTH (FT.)
400-1214	B1100	6

Slip Sleeve

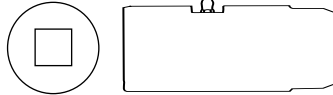

3/4" X 7/8" RECTANGULAR

SPECIFICATIONS

RB&H #	LENGTH (IN.)	FITS TUBE SIZE (IN.)
510-0600	4	1 1/2 (.065 Vwall)

With grease groove

Tube

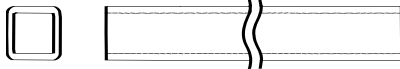

1" X 1 1/8" RECTANGULAR O.D.

SPECIFICATIONS

RB&H #	REFERENCE #	LENGTH (FT.)	FITS SHAFT (IN.)
600-1618	A1100	6	3/4 x 7/8

Tube Weld Yoke

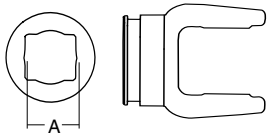

SPECIFICATIONS

RB&H #	REFERENCE #	DIM. "A" BORE (IN.)
700-0600	6RWY1618	1 x 1 1/8

*With bearing groove (Guard must rotate freely on yoke)

Spline Bore

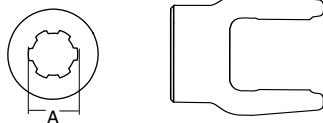

SPECIFICATIONS

RB&H #	REFERENCE #	DIM. "A" BORE (IN.)
801-0606	6R220-21	1 3/8 x 6
801-0618	6R180-21	1 1/8 x 6

With 1/4" pin hole

Shear Pin

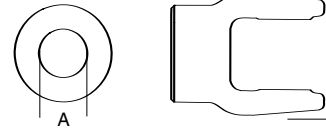

SPECIFICATIONS

RB&H #	REFERENCE #	DIM. "A" BORE (IN.)
802-0616*	6R160-7	1
802-0618*	6R180-7	1 1/8
802-0620*	6R200-7	1 1/4

*With 1/4" pin hole

Square Bore



SPECIFICATIONS

RB&H #	REFERENCE #	DIM. "A" BORE (IN.)
804-0612	6R120-26	3/4
804-0614	6R140-26	7/8
804-0616	6R160-26	1
804-0618	6R180-26	1 1/8
804-0620	6R200-26	1 1/4

With set screw

Round Bore

KEYWAY & SET SCREW

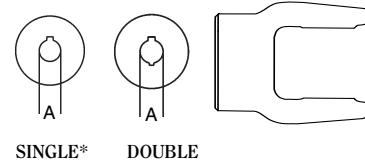

SPECIFICATIONS

RB&H #	DIM. "A" BORE (IN.)	KEYWAY (IN.)
800-0610*	5/8	3/16
806-0612	3/4	3/16 & 1/4
806-0613	13/16	3/16 & 1/4
806-0614	7/8	3/16 & 1/4
800-0615*	15/16	1/4
806-0616	1	3/16 & 1/4
806-0618	1 1/8	1/4 & 9/16
806-0619	1 3/16	1/4 & 9/16
806-0620	1 1/4	1/4 & 9/16

AGRICULTURAL PARTS

6 SERIES

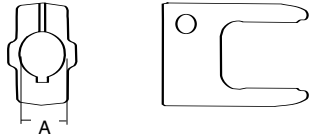

Clamp Yoke

SPECIFICATIONS		
RB&H #	REFERENCE #	KEYWAY (IN.)
807-0616	1	1/4

With bolt & set screw

Slip Sleeve Yoke

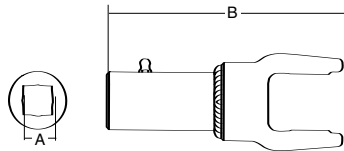

SPECIFICATIONS		
RB&H #	DIM. "A" BORE (IN.)	DIM. "B" LENGTH (IN.)
808-0612	3/4 sq.	5 1/2
808-0614	7/8 sq.	5 1/2

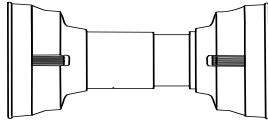

Plastic Guards

SPECIFICATIONS		
RB&H #	REFERENCE #	DIM. "A" BORE (IN.)
900-2548	PS6RL48	48
900-2560		60

With Bearings (921-0600) (2 per kit)

NOTE: When installing metal or plastic guards observe the following:
 1) Install proper nylon bearing and retainer
 2) Check to insure guards turn freely on bearing

Yoke & Shaft Assembly

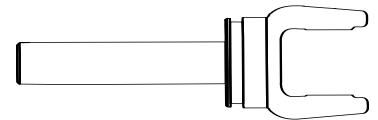

SPECIFICATIONS			
RB&H #	REFERENCE #	SHAFT SIZE (IN.)	CENTERLINE TO END OF SHAFT DIMENSION
10000648	6R48M	3/4 x 7/8	38.75

Yoke & Tube Assembly

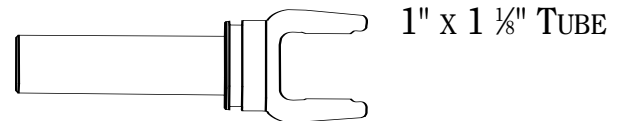

SPECIFICATIONS			
RB&H #	REFERENCE #	SHAFT SIZE (IN.)	CENTERLINE TO END OF TUBE DIMENSION
11000648	6R48F	3/4 x 7/8	38.75