

AGRICULTURAL PARTS

55 SERIES

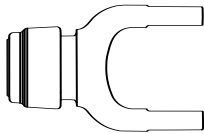
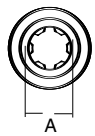
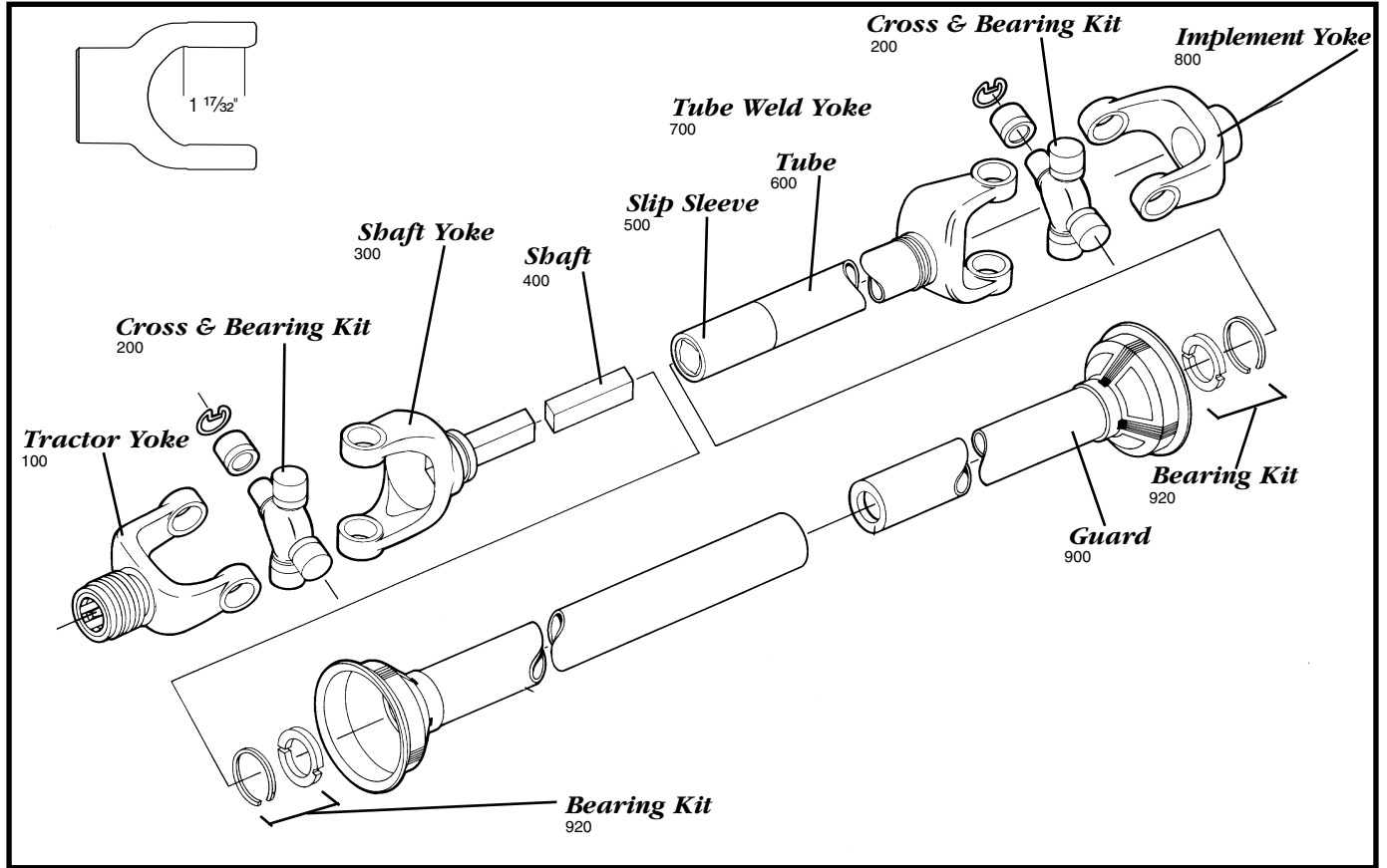

**Tractor Yoke
Safety Slide
Lock**

SPECIFICATIONS		
RB&H #	REFERENCE #	DIM. "A" BORE (IN.)
101-5506	55R220-20-SS	1 3/8 x 6
101-5521	55R220-TQD-SS	1 3/8 x 21
101-5520	-	1 3/4 x 20

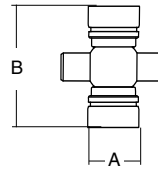

**Cross & Bearing
Kit**

SPECIFICATIONS			
RB&H #	REFERENCE #	DIM. "A" BORE (IN.)	DIM. "B" BORE (IN.)
200-5500	55R	1 17/32	4 5/16
201-5500	Extended Life	1 17/32	4 5/16

Snap ring located in bushing

Quick Disconnect

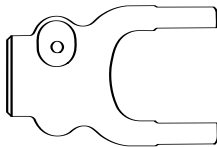
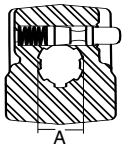

SPECIFICATIONS		
RB&H #	REFERENCE #	DIM. "A" BORE (IN.)
102-5506	55R220-20	1 3/8 x 6
102-5521	55R220-TQD	1 3/8 x 21
102-5520	-	1 3/4 x 20

Repair kit — page 200

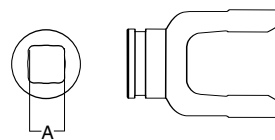

**Shaft Weld
Yoke**

SPECIFICATIONS			
RB&H #	REFERENCE #	DIM. "A" BORE (IN.)	DIM. "B" BORE (IN.)
300-5500	55RWY2100	1 9/16 sq.	-
302-5500	-	-	1 11/16 x 20

With bearing groove
(Guard must rotate freely on yoke)

AGRICULTURAL PARTS

55 SERIES

Shaft

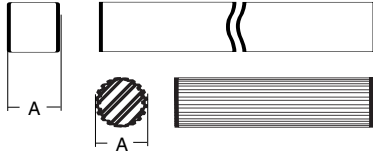

SPECIFICATIONS				
RB&H #	REFERENCE #	DIM. "A" BORE (IN.)	LENGTH (IN.)	SHAPE
400-0021	B1312	1 5/16	6	Square
404-2720	-	1 11/16 x 20	3	Round

Implement Yoke

Round Bore

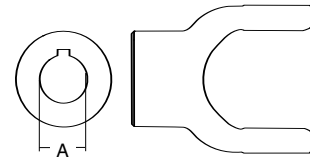

SPECIFICATIONS		
RB&H #	DIM. "A" BORE (IN.)	KEYWAY
800-5522	1 3/8	5/16
800-5524	1 1/2	3/8
800-5526	1 5/8	3/8
800-5528	1 3/4	3/8
800-5532	2	1/2

With keyway & set screw

Slip Sleeve

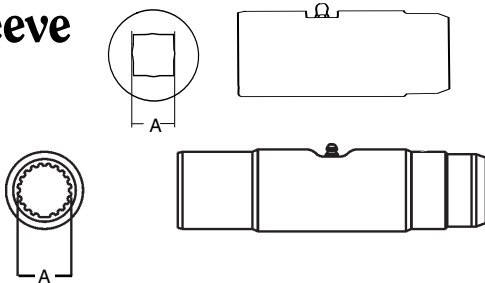

SPECIFICATIONS					
RB&H #	REFERENCE #	LENGTH (IN.)	DIM. "A" BORE (IN.)	DIM. "B" BORE (IN.)	SHAPE
500-4400	44-55RS06	5	1 5/16	2 1/2 (.134 Wall)	Square
503-3500	-	8	1 11/16 x 20	2 1/2	Round

With grease groove

Spline Bore

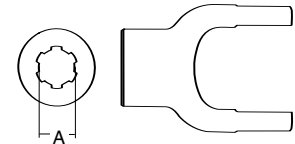

SPECIFICATIONS		
RB&H #	REFERENCE #	DIM. "A" BORE (IN.)
801-5506	55R220-21	1 3/8 x 6

With 2 1/4" pin hole

Tube

2 1/2" (.120 Wall)



SPECIFICATIONS		
RB&H #	REFERENCE #	DIM. "A" BORE (IN.)
602-4400	44RTT	6

Clamp Yoke

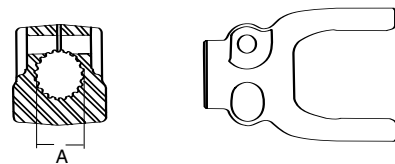

SPECIFICATIONS	
RB&H #	DIM. "A" BORE (IN.)
807-5520	1 3/4 x 20

Tube Weld Yoke

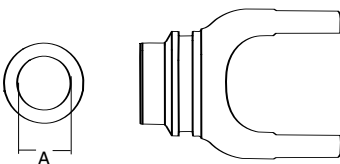

SPECIFICATIONS		
RB&H #	REFERENCE #	DIM. "A" BORE (IN.)
701-5500	55RWY2200	2 1/2 (.120 Wall)

With bearing groove
(Guard must rotate freely on yoke)

AGRICULTURAL PARTS

55 SERIES

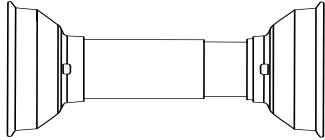

Guard

Plastic Guard

SPECIFICATIONS	
RB&H #	OVERALL DRIVELINE LENGTH (IN.)
902-3548	48
902-3560	60

NOTE: When installing bearings (921-4400) guards observe the following:

- 1) Install proper nylon bearing and retainer
- 2) Check to insure guards turn freely on bearing

Yoke & Shaft Assembly

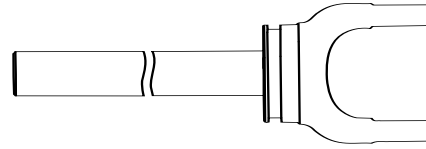

1 5/16" Square Shaft

SPECIFICATIONS	
RB&H #	CENTERLINE TO END OF SHAFT DIMENSION LENGTH (IN.)
10005548	32.75

Yoke, Tube & Sleeve Assembly

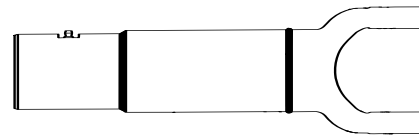

1 5/16" Square

SPECIFICATIONS	
RB&H #	CENTERLINE TO END OF TUBE DIMENSION LENGTH (IN.)
11005548	33.38